

KOMATSU

PW198-11

PRELIMINARY



Hydraulic wheeled excavator

Engine power
129 kW / 173 HP @ 2000 rpm

Operating weight
17435 - 19355 kg

Bucket capacity
max. 1.13 m³

PW198-11



Engine power

129 kW / 173 HP @ 2000 rpm

Operating weight

17435 - 19355 kg

Bucket capacity

max. 1.13 m³

High versatility, low transportation height and safe performance in tight spaces

Powerful and environmentally friendly

- NEW** • 129 kW EU Stage V engine
- NEW** • Long-life Komatsu Diesel Particulate Filter
- NEW** • 8000 hrs KDPF cleaning interval
- NEW** • High lifting force
- NEW** • Lower fuel consumption: -8% l/h vs. PW180-11
- NEW** • Productivity up: +20% vs. PW180-11
- NEW** • HVO Diesel fuel ready
- Speedometer for road homologation

Total versatility

- NEW** • Axles & gear box
- NEW** • Plastic fenders (option)
- NEW** • Mounting seats for 3D aftermarket systems
- NEW** • Preparation for tilt rotator implementation
- 2.75 m wide axle (option)
- Joystick steering system (option)

First-class operator comfort

- NEW** • Tilttable steering column
- NEW** • Document holder storage
- NEW** • Mounting bracket for 3rd party monitor
- NEW** • Wider entrance space
- NEW** • Low noise level inside and outside
- Automatic digging brake (option)
- High comfort operator seat (option)

A safe investment

- NEW** • Low transportation height
- NEW** • Compact dimensions
- NEW** • Colored steps and handrails
- NEW** • AdBlue® tank hood
- KomVision surround view system

Easy maintenance

- NEW** • Easy access sheet metal door for AdBlue® tank and refill pump
- NEW** • Clamshell grip bar (option)
- Large access doors for maintenance
- Ground level access for filters and maintenance

Komtrax

- Komtrax Step 5 for ultimate machinery management
- NEW** • 4G mobile communications including KCSI controller
- Current fuel consumption displayed
- Komtrax energy saving report
- Easy maintenance planning
- Locating



A maintenance program
for Komatsu customers

Specifications

Engine

Model	Komatsu SAA4D107E-5
Type	Common rail direct injection, water-cooled, emissionised, turbocharged, after-cooled diesel
Engine power	
at rated engine speed	2000 rpm
ISO 14396	129 kW / 173 HP
ISO 9249 (net engine power)	125 kW / 168 HP
No. of cylinders	4
Bore × stroke	107 × 124 mm
Displacement	4.5 l
Alternator	85 A / 24 V
Starting motor	4.5 kW / 24 V
Air filter type	Double element type with monitor panel dust indicator and auto dust evacuator
Cooling	Suction type cooling fan with radiator fly screen
Fuel	Diesel fuel, conforming to EN590 Class 2/ Grade D. Paraffinic fuel capability (HVO, GTL, BTL), conforming to EN 15940:2016

Hydraulic system

Type	HydrauMind. Closed-centre load sensing system with pressure compensation valves
Additional circuits	Depending on the specification up to 2 additional proportional control & quick-coupler circuits can be installed
Main pump	Variable displacement piston pump supplying boom, arm, bucket, swing and travel circuits
Maximum pump flow	295 l/min
Relief valve settings	
Implement	380 kg/cm ²
Travel	420 kg/cm ²
Swing	290 kg/cm ²
Pilot circuit	36 kg/cm ²

Swing system

Type	Axial piston motor driving through planetary double reduction gearbox
Swing lock	Electrically actuated wet multi-disc brake integrated into swing motor
Swing speed	0 - 11.5 rpm
Swing torque	43 kNm

Steering system

Steering control	Hydraulic steering system supplied from a separate gear pump and controlled through LS orbitrol & priority valves
Minimum turning radius	6800 mm

Brake system

Type	Dual circuit hydraulic braking system supplied from a separate gear pump
Service brakes	Pedal actuated wet multi-disc brakes integrated into the axle hubs
Parking brake	Electrically actuated wet multi-disc "spring actuation hydraulic release" brake integrated into the transmission

Transmission

Type	Fully automatic power shift transmission with permanent 4 wheel drive
Travel motors	1 variable displacement axial piston motor
Maximum pressure	380 bar
Travel modes	Automatic + 3 travel modes
Max. travel speeds	
Hi / Lo / Creep	35.0 / 10.0 / 2.5 km/h
	A max. speed restriction of 20 km/h is available as an option
Maximum drawbar pull	10900 kg
Axle oscillation	8° Lockable in any position from the operator cab

Service refill capacities

Fuel tank	267 l
Radiator	22 l
Engine oil	18 l
Swing drive	5.5 l
Hydraulic tank	90 l
Transmission	3.0 l
Front differential	9.5 l
Rear differential	12.4 l
Front axle hub	2.5 l
Rear axle hub	2.5 l
Swing pinion grease bath amount	9.0 l
AdBlue® tank	57.7 l

Environment

Engine emissions	Fully complies with EU Stage V exhaust emission regulations
Noise levels	
LwA external	100 dB(A) (2000/14/EC Stage II)
LpA operator ear	69 dB(A) (ISO 6396 dynamic test)
Vibration levels (EN 12096:1997)	
Hand/arm	≤ 2.5 m/s ² (uncertainty K = 0.34 m/s ²)
Body	≤ 0.5 m/s ² (uncertainty K = 0.16 m/s ²)
Contains fluorinated greenhouse gas HFC-134a (GWP 1430). Quantity of gas 0.9 kg; CO ₂ equivalent 1.29 t	

Operating weight (appr.)

Arm length	2100 mm		2500 mm		3000 mm	
	2550 mm	2750 mm	2550 mm	2750 mm	2550 mm	2750 mm
Axle						
Undercarriage attachment type						
Without	17387 kg	17434 kg	17436 kg	17483 kg	17494 kg	17541 kg
Rear blade	18128 kg	18195 kg	18177 kg	18244 kg	18235 kg	18302 kg
2 blades	18869 kg	18956 kg	18918 kg	19005 kg	18976 kg	19063 kg
Rear outriggers	18346 kg	18479 kg	18395 kg	18528 kg	18453 kg	18586 kg
2 outriggers + blade	19087 kg	19240 kg	19136 kg	19289 kg	19194 kg	19347 kg
4 outriggers	19305 kg	19524 kg	19354 kg	19573 kg	19412 kg	19631 kg

Operating weight, including specified work equipment, Tire 10.00-20 16PR NB38 MITAS, operator, lubricant, coolant, full fuel tank, bucket (530 kg) and the standard equipment.

Max. bucket capacity and weight

Arm length	2100 mm		2500 mm		3000 mm	
	1.13 m ³	770 kg	1.13 m ³	770 kg	1.13 m ³	770 kg
Material weight up to 1.2 t/m ³	1.13 m ³	770 kg	1.13 m ³	770 kg	1.13 m ³	770 kg
Material weight up to 1.5 t/m ³	1.13 m ³	770 kg	1.13 m ³	770 kg	0.94 m ³	680 kg
Material weight up to 1.8 t/m ³	1.13 m ³	770 kg	1.13 m ³	770 kg	0.85 m ³	640 kg

Max. capacity and weight have been calculated according to ISO 10567:2007.

Please consult with your distributor for the correct selection of buckets and attachments to suit the application.

Bucket and arm force

Arm length	2100 mm	2500 mm	3000 mm
Bucket digging force	102 kN	102 kN	102 kN
Bucket digging force at PowerMax	111 kN	111 kN	111 kN
Arm crowd force	80 kN	72 kN	64 kN
Arm crowd force at PowerMax	87 kN	78 kN	69 kN

Dimensions and performance figures

Two-piece boom

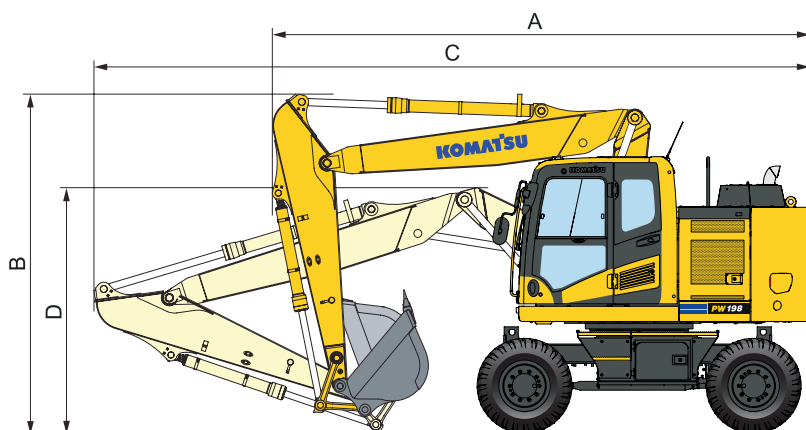

Driving position

Arm length	A	B
2100 mm	5955 mm	3980 mm
2500 mm	6000 mm	3985 mm
3000 mm *	6320 mm	3960 mm

Transport position

Arm length	C	D **
2100 mm	8100 mm	2810 mm
2500 mm	8090 mm	2920 mm
3000 mm	8060 mm	3090 mm

* Driving position without bucket

** Height to top of hose

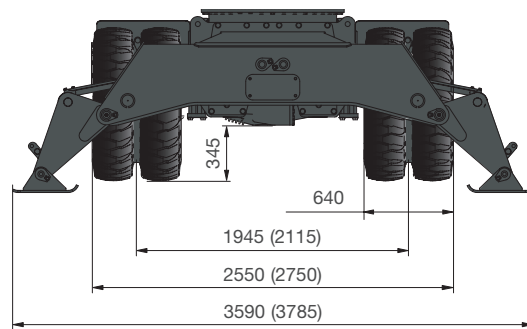
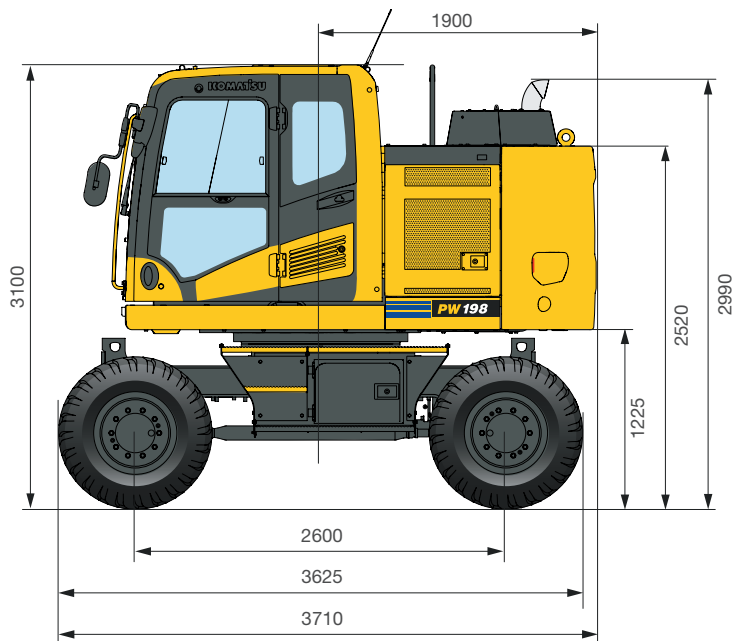

All dimensions with tyres Bandenmarkt Excavator 315/70 R22.5

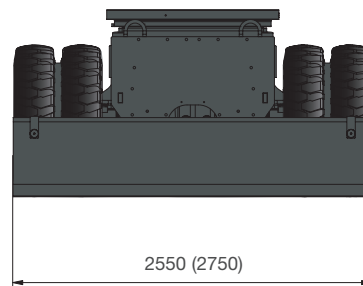

(): Figures for 2.75 m undercarriage

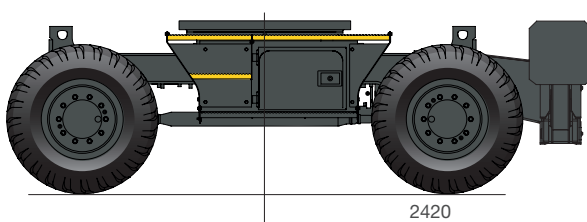
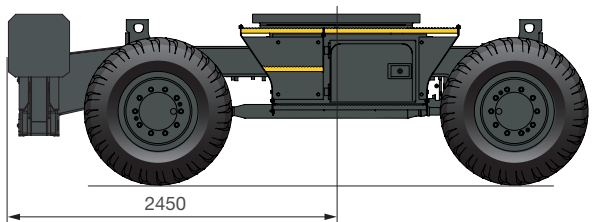
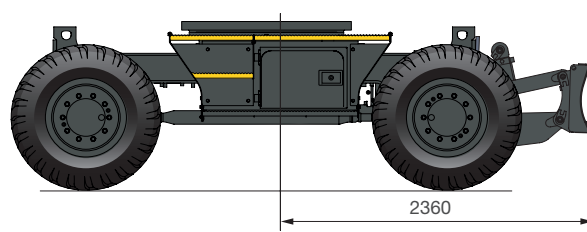
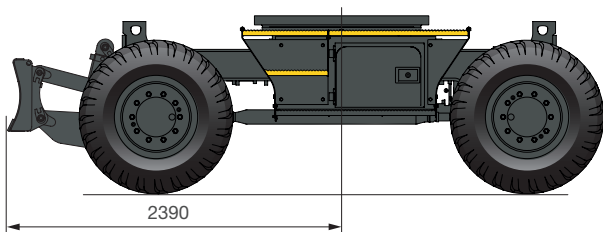

Working range

Two-piece boom

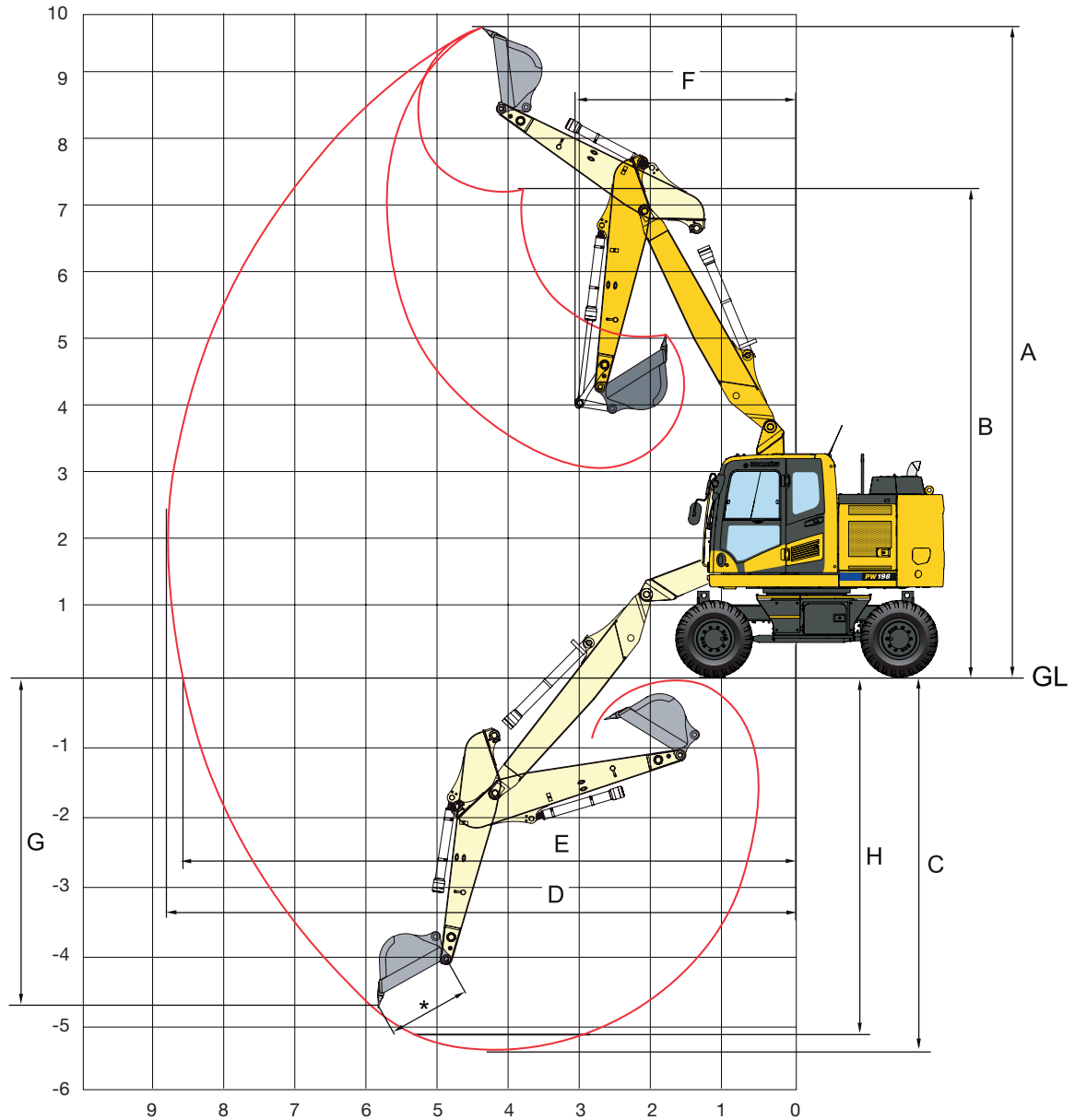



Arm length	2100 mm	2500 mm	3000 mm
A Max. digging height	9635 mm	9910 mm	10255 mm
B Max. dumping height	7045 mm	7320 mm	7665 mm
C Max. digging depth	5210 mm	5605 mm	6095 mm
D Max. digging reach	8700 mm	9065 mm	9520 mm
E Max. digging reach at ground level	8470 mm	8885 mm	9330 mm
F Min. swing radius	2625 mm	2755 mm	2910 mm
G Max. vertical wall digging depth	3670 mm	4040 mm	4510 mm
H Max. digging depth of cut for 2440 mm level	5025 mm	5435 mm	5945 mm

Lifting capacity / two-piece boom / undercarriage width 2.55 m

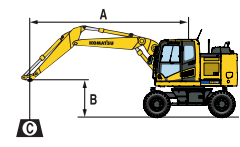







Arm length	A	7.5 m		6.0 m		4.5 m		3.0 m		1.5 m				
		Rating over front	Rating over side	Rating over front	Rating over side	Rating over front	Rating over side	Rating over front	Rating over side	Rating over front	Rating over side			
 <p>Without stabiliser</p>	2100 mm	7.5 m	kg	*3850	*3850			*4750	4550					
		6.0 m	kg	*3350	2650		4050	2900	*5350	4600				
		4.5 m	kg	3000	2150		3950	2850	6200	4400	*6650	*6650		
		3.0 m	kg	2700	1900	2700	1950	3800	2700	5850	4050			
		1.5 m	kg	2600	1800	2700	1850	3650	2550	5500	3750			
		0.0 m	kg	2650	1850			3550	2450	5300	3600			
		-1.5 m	kg	2950	2050			3500	2400	5250	3550	*8750	6400	
		-3.0 m	kg	3750	2600					5350	3600			
		-4.5 m	kg											
	2500 mm	7.5 m	kg	*3300	*3300				*4450	*4450				
		6.0 m	kg	*2950	2400		4050	2950	*4500	*4500				
		4.5 m	kg	2800	1950		4000	2850	*5250	4500				
		3.0 m	kg	2550	1800	2700	1950	3850	2700	5950	4150			
		1.5 m	kg	2400	1650	2650	1850	3700	2550	5550	3800			
		0.0 m	kg	2450	1700	2600	1800	3550	2450	5300	3600			
		-1.5 m	kg	2700	1850			3500	2400	5250	3500	*8350	6300	
		-3.0 m	kg	3300	2250			3500	2400	5250	3550			
		-4.5 m	kg											
	3000 mm	7.5 m	kg	*2500	*2500		2750	2750						
		6.0 m	kg	*2300	2100		3650	3000						
		4.5 m	kg	*2250	1800	2850	2000	4050	2900	*4000	*4000			
		3.0 m	kg	*2250	1600	2750	1950	3900	2750	6050	4200			
		1.5 m	kg	2200	1500	2650	1850	3700	2550	5650	3850			
		0.0 m	kg	2250	1550	2550	1800	3550	2400	5350	3600	*5400	*5400	
		-1.5 m	kg	2400	1650	2550	1750	3450	2350	5250	3450	*7700	6200	
		-3.0 m	kg	2850	1950			3450	2350	5200	3450	10100	6300	
		-4.5 m	kg											
	 <p>Front or rear blade</p>	2100 mm	7.5 m	kg	*3850	*3850			*4750	*4750				
			6.0 m	kg	*3350	3050		*4350	3300	*5350	5250			
			4.5 m	kg	*3250	2500		*5650	3300	*6450	5100	*6650	*6650	
			3.0 m	kg	*3300	2250	*3600	2250	*6250	3150	*8000	4750		
			1.5 m	kg	*3500	2100	*4550	2200	*6750	3000	*9200	4400		
			0.0 m	kg	*3900	2150			*7000	2900	*9650	4200		
			-1.5 m	kg	*4700	2400			*6650	2850	*9000	4200	*8750	7700
			-3.0 m	kg	*5350	3050					*7400	4250		
			-4.5 m	kg										
2500 mm		7.5 m	kg	*3300	*3300				*4450	*4450				
		6.0 m	kg	*2950	2800		*4250	3400	*4500	*4500				
		4.5 m	kg	*2850	2300		*5000	3300	*5250	5150				
		3.0 m	kg	*2900	2100	*4300	2250	*6000	3150	*7550	4800			
		1.5 m	kg	*3050	1950	*5200	2200	*6600	3000	*8950	4450			
		0.0 m	kg	*3400	2000	*5250	2100	*6950	2850	*9550	4200			
		-1.5 m	kg	*4100	2200			*6750	2850	*9300	4150	*8350	7650	
		-3.0 m	kg	*5000	2650			*5650	2850	*8000	4200			
		-4.5 m	kg											
3000 mm		7.5 m	kg	*2500	*2500		*2750	*2750						
		6.0 m	kg	*2300	*2300		*3650	3450						
		4.5 m	kg	*2250	2100	*3300	2350	*4100	3350	*4000	*4000			
		3.0 m	kg	*2250	1900	*4100	2250	*5350	3200	*6750	4900			
		1.5 m	kg	*2350	1800	*5000	2200	*6350	3000	*8500	4500			
		0.0 m	kg	*2650	1800	5300	2100	*6800	2850	*9350	4250	*5400	*5400	
		-1.5 m	kg	*3050	1950	*4850	2100	*6850	2800	*9350	4100	*7700	7550	
		-3.0 m	kg	*4000	2300			*6150	2800	*8500	4100	*11700	7650	
		-4.5 m	kg											



- A - Reach from swing center
 - B - Bucket hook height
 - C - Lifting capacities, including bucket linkage (190 kg) and bucket cylinder (104 kg)
-  - Rating over front
 -  - Rating over side
 -  - Rating at maximum reach

When removing linkage or cylinder, lifting capacities can be increased by their respective weights.

* Load is limited by hydraulic capacity rather than tipping. Ratings are based on ISO standard 10567. Rated loads do not exceed 87% of hydraulic lift capacity or 75% of tipping load.

Arm length	A	⊗		7.5 m		6.0 m		4.5 m		3.0 m		1.5 m		
		B												
 Rear outrigger	2100 mm	7.5 m	kg	*3850	*3850			*4750	*4750					
		6.0 m	kg	*3350	*3350			*4350	4100	*5350	*5350			
		4.5 m	kg	*3250	3100			*5650	4050	*6450	6300	*6650	*6650	
		3.0 m	kg	*3300	2750	*3600	2800	*6250	3900	*8000	6000			
		1.5 m	kg	*3500	2650	*4550	2700	*6750	3750	*9200	5650			
		0.0 m	kg	*3900	2700			*7000	3650	*9650	5400			
		-1.5 m	kg	*4700	3000			*6650	3600	*9000	5400	*8750	*8750	
		-3.0 m	kg	*5350	3850					*7400	5450			
		-4.5 m	kg											
	2500 mm	7.5 m	kg	*3300	*3300				*4450	*4450				
		6.0 m	kg	*2950	*2950			*4250	4200	*4500	*4500			
		4.5 m	kg	*2850	*2850			*5000	4100	*5250	*5250			
		3.0 m	kg	*2900	2550	*4300	2800	*6000	3900	*7550	6050			
		1.5 m	kg	*3050	2500	5150	2700	*6600	3750	*8950	5700			
		0.0 m	kg	*3400	2550	5100	2700	*6950	3600	*9550	5400			
		-1.5 m	kg	*4100	2750			*6750	3600	*9300	5350	*8350	*8350	
		-3.0 m	kg	*5000	3350			*5650	3600	*8000	5400			
		-4.5 m	kg											
	3000 mm	7.5 m	kg	*2500	*2500			*2750	*2750					
		6.0 m	kg	*2300	*2300			*3650	*3650					
		4.5 m	kg	*2250	*2250	*3300	2900	*4100	*4100	*4000	*4000			
		3.0 m	kg	*2250	*2250	*4100	2850	*5350	3950	*6750	6150			
		1.5 m	kg	*2350	2250	*5000	2700	*6350	3750	*8500	5750			
		0.0 m	kg	*2650	2300	5100	2650	*6800	3600	*9350	5450	*5400	*5400	
-1.5 m		kg	*3050	2500	*4850	2600	*6850	3550	*9300	5300	*7700	*7700		
-3.0 m		kg	*4000	2900			*6150	3550	*8500	5300	*11700	10250		
-4.5 m		kg												
 Outrigger + blade	2100 mm	7.5 m	kg	*3850	*3850			*4750	*4750					
		6.0 m	kg	*3350	*3350			*4350	*4350	*5350	*5350			
		4.5 m	kg	*3250	*3250			*5650	5000	*6450	*6450	*6650	*6650	
		3.0 m	kg	*3300	*3300	*3600	3450	*6250	4850	*8000	7550			
		1.5 m	kg	*3500	3300	*4550	3400	*6750	4700	*9200	7150			
		0.0 m	kg	*3900	3400			*7000	4600	*9650	6950			
		-1.5 m	kg	*4700	3750			*6650	4550	*9000	6900	*8750	*8750	
		-3.0 m	kg	*5350	4850					*7400	7000			
		-4.5 m	kg											
	2500 mm	7.5 m	kg	*3300	*3300				*4450	*4450				
		6.0 m	kg	*2950	*2950			*4250	*4250	*4500	*4500			
		4.5 m	kg	*2850	*2850			*5000	*5000	*5250	*5250			
		3.0 m	kg	*2900	*2900	*4300	3450	*6000	4900	*7550	*7550			
		1.5 m	kg	*3050	*3050	*5200	3400	*6600	4700	*8950	7200			
		0.0 m	kg	*3400	3150	*5250	3350	*6950	4550	*9550	6950			
		-1.5 m	kg	*4100	3450			*6750	4500	*9300	6900	*8350	*8350	
		-3.0 m	kg	*5000	4200			*5650	4550	*8000	6900			
		-4.5 m	kg											
	3000 mm	7.5 m	kg	*2500	*2500			*2750	*2750					
		6.0 m	kg	*2300	*2300			*3650	*3650					
		4.5 m	kg	*2250	*2250	*3300	*3300	*4100	*4100	*4000	*4000			
		3.0 m	kg	*2250	*2250	*4100	3500	*5350	4950	*6750	*6750			
		1.5 m	kg	*2350	*2350	*5000	3400	*6350	4750	*8500	7300			
		0.0 m	kg	*2650	*2650	*5400	3300	*6800	4550	*9350	6950	*5400	*5400	
-1.5 m		kg	*3050	*3050	*4850	3300	*6850	4500	*9350	6850	*7700	*7700		
-3.0 m		kg	*4000	3650			*6150	4500	*8500	6850	*11700	*11700		
-4.5 m		kg												

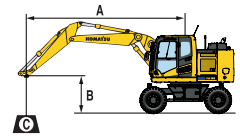

A – Reach from swing center

B – Bucket hook height

C – Lifting capacities, including bucket linkage (190 kg) and bucket cylinder (104 kg)

 – Rating over front

 – Rating over side

 – Rating at maximum reach

When removing linkage or cylinder, lifting capacities can be increased by their respective weights.

* Load is limited by hydraulic capacity rather than tipping. Ratings are based on ISO standard 10567. Rated loads do not exceed 87% of hydraulic lift capacity or 75% of tipping load.

Arm length	A	B	⊗		7.5 m		6.0 m		4.5 m		3.0 m		1.5 m		
			⊗	⊗	⊗	⊗	⊗	⊗	⊗	⊗	⊗	⊗	⊗	⊗	
 <p>Outrigger front + rear</p>	2100 mm	7.5 m	kg	*3850	*3850				*4750	*4750					
		6.0 m	kg	*3350	*3350			*4350	*4350	*5350	*5350				
		4.5 m	kg	*3250	*3250			*5650	*5650	*6450	*6450	*6650	*6650		
		3.0 m	kg	*3300	*3300	*3600	*3600	*6250	5900	*8000	*8000				
		1.5 m	kg	*3500	*3500	*4550	4150	*6750	5750	*9200	9000				
		0.0 m	kg	*3900	*3900			*7000	5600	*9650	8750				
	2500 mm	- 1.5 m	kg	*4700	4600			*6650	5550	*9000	8700	*8750	*8750		
		- 3.0 m	kg	*5350	*5350					*7400	*7400				
		- 4.5 m	kg												
		7.5 m	kg	*3300	*3300					*4450	*4450				
		6.0 m	kg	*2950	*2950			*4250	*4250	*4500	*4500				
		4.5 m	kg	*2850	*2850			*5000	*5000	*5250	*5250				
3000 mm	3.0 m	kg	*2900	*2900	*4300	4200	*6000	5950	*7550	*7550					
	1.5 m	kg	*3050	*3050	*5200	4150	*6600	5750	*8950	*8950					
	0.0 m	kg	*3400	*3400	*5250	4050	*6950	5600	*9550	8750					
	- 1.5 m	kg	*4100	*4100			*6750	5550	*9300	8700	*8350	*8350			
	- 3.0 m	kg	*5000	*5000			*5650	5600	*8000	*8000					
	- 4.5 m	kg													
	7.5 m	kg	*2500	*2500			*2750	*2750							
	6.0 m	kg	*2300	*2300			*3650	*3650							
	4.5 m	kg	*2250	*2250	*3300	*3300	*4100	*4100	*4000	*4000					
	3.0 m	kg	*2250	*2250	*4100	*4100	*5350	*5350	*6750	*6750					
	1.5 m	kg	*2350	*2350	*5000	4150	*6350	5800	*8500	*8500					
	0.0 m	kg	*2650	*2650	*5400	4050	*6800	5600	*9350	8750	*5400	*5400			
- 1.5 m	kg	*3050	*3050	*4850	4050	*6850	5550	*9350	8600	*7700	*7700				
- 3.0 m	kg	*4000	*4000			*6150	5550	*8500	*8500	*11700	*11700				
- 4.5 m	kg														

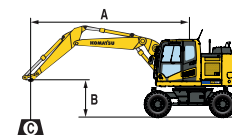

A – Reach from swing center

B – Bucket hook height

C – Lifting capacities, including bucket linkage (190 kg) and bucket cylinder (104 kg)

 – Rating over front

 – Rating over side

 – Rating at maximum reach

When removing linkage or cylinder, lifting capacities can be increased by their respective weights.

* Load is limited by hydraulic capacity rather than tipping. Ratings are based on ISO standard 10567. Rated loads do not exceed 87% of hydraulic lift capacity or 75% of tipping load.

